

CREATION OF RESTRICTION 12

UPON REGISTRATION OF THIS PLAN THE FOLLOWING RESTRICTION IS TO BE CREATED.

LAND TO BENEFIT: Lots 1201 to 1245 (both inclusive).

LAND TO BURDEN: Lots 1201 to 1245 (both inclusive).

The registered proprietor or proprietors for the time being of any lot forming part of the Land to be burdened must not, without the permission of the Responsible Authority, construct or permit to be constructed;

1. In the case of lots containing a building envelope zone, as shown in MCP No. AAAA, any dwelling outside the relevant building height and setback profiles shown in MCP No. AAAA and;
2. Any dwelling other than in accordance with MCP No. AAAA
3. Any building on a lot unless the plans for such a building are endorsed as being in accordance with the Riverfield Estate Design Guidelines prior to the issue of a building permit.

These restrictions will cease to affect any of the burdened lots 10 years after registration of this plan.

Memorandum of common provisions
Restrictive covenants in a plan
Section 91A Transfer of Land Act 1958

Privacy Collection Statement

The information in this form is collected under statutory authority and is used for the purpose of maintaining publicly searchable registers and indexes.

Lodged by	
Name:	
Phone:	
Address:	
Reference:	
Customer code:	

This memorandum contains provisions which are intended for inclusion in plans under the Subdivision Act 1988 to be subsequently lodged for registration.

Burdened Land: As set out in the Plan of Subdivision

Benefited Land: As set out in the Plan of Subdivision

Covenants:

A. Preliminary

- A. This MCP (Version 1) has been prepared by or on behalf of Riverfield in order to regulate the siting, form and design of residential development in accordance with the Riverfield Design Guidelines.
- B. This MCP, in conjunction with the plan of subdivision and building envelope plan, provides the information necessary to interpret the approved building envelopes.
- C. Some of the matters addressed in this MCP are not covered by or are amendments to the Regulations and Scheme or Code (as they may apply to each particular lot).
- D. This MCP is retained by the Registrar of Titles pursuant to section 91(A) of the Transfer of Land Act.

B. Provisions

- A. Small Lot Housing Code
Lots identified as Type A or Type B on the building envelope plans are lots to which the Code applies.
- B. Any building:
 - a) to be constructed on lots to which this MCP applies; and
 - b) for which the construction would require a building permit,must be sited within the approved building envelope subject to:

35402012

V3

1. The provisions are to be numbered consecutively from number 1.
2. Further pages may be added but each page should be consecutively numbered.
3. To be used for the inclusion of provisions in plans.

91ATLA

Page 1 of 17

THE BACK OF THIS FORM MUST NOT BE USED

Land Use Victoria contact details: see www.delwp.vic.gov.au/property>Contact us

Memorandum of common provisions

Section 91A Transfer of Land Act 1958

- c) any specific encroachments allowed outside the approved building envelope pursuant to this MCP;
and
- d) the restrictions imposed by this MCP, the plan of subdivision and any other applicable control.

1. Edge Lots (Regulation 71 and clause 56.04-2)

Regulation 71 of the Regulations and clause 56.04-2 in the Scheme, apply to each Edge Lot irrespective of Sections 2 to 6 of this MCP.

2. Minimum street setbacks (regulation 74 of the Regulations and clause 54.03-1 of the Scheme or Clause 2 of Part 1 of the Code)

- 2.1. The building on a lot must be set back from a street frontage boundary in accordance with the applicable setback identified in the building envelope plans
- 2.2. Where a side boundary abuts a street or public open space, a building may encroach up to 300 millimetres into the setback specified in the building envelope plan for maximum length of 10 per cent of the building wall facing that side street.
- 2.3. Balconies, pergolas, verandahs, porches, covered walkways and porticos, facade treatments and/or covered balconies or verandahs on the second storey of a building that are less than 6.9m above natural ground level may encroach not more than 1.0 metre into the minimum front setback and the minimum secondary frontage setback specified in the building envelope plan.
Pergolas, verandahs, porches, covered walkways, facade treatments and porticos that are less than 3.6m above natural ground level may encroach not more than 1.0 metre into the minimum front setback and the minimum secondary frontage setback specified in the building envelope plan
- 2.4. Eaves, fascias and gutters not exceeding 600mm in total width may encroach into the setback specified in the building envelope plan for a front boundary and/or a boundary which abuts a street or public open space.

Garages

- 2.5. For **rear loaded lots** any garage must be constructed to allow vehicle access from the boundary so marked on the building envelope plan.
- 2.6. For all lots other than lots subject to the Small Lot Housing Code:
 - 2.6.1. garage openings may not occupy:
 - a) with respect to lots with an area between 250 and 300 square metres and on which a two or more storey dwelling is constructed, more than 30% of the area of the front facade of the dwelling, with the area of the front facade measured from a two-dimensional (2-D) elevation plan excluding any area of the roof of the dwelling;
 - b) with respect to all other lots, 40% of the width of the lot frontage, unless the dwelling is to be two or more storeys;
 - 2.6.2. The garage must be set back a minimum of 5.5 metres from the front boundary.

Memorandum of common provisions

Section 91A Transfer of Land Act 1958

3. **Side and rear setbacks (regulation 79 of the Regulations and clause 54.04-1 in the Scheme or Clause 7 of Part 1 of the Code)**
 - 3.1. The building on a lot must be set back from side and rear boundaries in accordance with the applicable setback profiles as identified in the building envelope plans.
 - 3.2. If a lot is shown with a profile identifier codes A and B on opposite boundaries, the codes may be interchanged.
 - 3.3. the following building elements may encroach up to 500 millimetres into the minimum side and rear setbacks specified in the building envelope plans:
 - 3.3.1. verandahs, porches, covered walkways;
 - 3.3.2. masonry chimneys, flues and pipes;
 - 3.3.3. sunblinds and screens (to the extent necessary to protect the neighbouring property from a direct view);
 - 3.3.4. fuel tanks and water tanks; and
 - 3.3.5. heating and cooling equipment and other services
 - 3.4. The following building elements may encroach into the minimum side and rear setback specified in the building envelope plans:
 - 3.4.1. pergolas and shade sails;
 - 3.4.2. landings with a maximum area of 2 square metres and a maximum height of 1 metre
 - 3.4.3. unroofed stairways and ramps;
 - 3.4.4. outbuildings not exceeding 12 square metres in area and 2.5 metres in height; and
 - 3.4.5. eaves, fascias and gutters not exceeding 600mm in total width.
4. **Walls on boundaries (regulation 80 of the Regulations and clause 54.04-2 in the Scheme or Clause 8 of Part 1 of the Code)**
 - 4.1. Construction within 200mm of a boundary is only permitted where the setback profiles identified in the building envelope plans indicate a building area on the boundary.
 - 4.2. For lots to which the Code applies, a wall constructed on a side or rear boundary of a lot can extend a maximum total length of:
 - 4.2.1. 60% of the total length of the side boundary; or
 - 4.2.2. the length of any simultaneously constructed abutting wall,whichever is the greater.

Memorandum of common provisions

Section 91A Transfer of Land Act 1958

5. Overlooking (regulation 84 of the Regulations and clause 54.04-6 in the Scheme or Clause 12 of Part 1 of the Code)

- 5.1. If a habitable room window, deck or raised open space is within an overlooking control area shown on the applicable setback profiles identified in the building envelope plans, it must be screened to 1.7m above finished floor level.

6. Fencing

- 6.1. Fencing plans must be submitted to and approved by the DRC as part of the design approval process set out in the Riverfield Design Guidelines.
- 6.2. All boundary fencing must be constructed prior to occupancy of any dwelling constructed on the Lot
- 6.3. No fencing will be permitted forward of the building line.

Side and Rear Fencing

- 6.4. For all lots, side and rear fencing (except for rear fences on **rear loaded lots** where the rear boundary abuts a reserve, or fencing along the secondary street frontage of a corner lot, or fencing along the side boundary which is shared with the rear boundary of a corner lot) must:
- 6.4.1. be constructed from capped timber palings with exposed timber posts (75mm x 125mm);
- 6.4.2. not exceed 1.95 metres in height;
- finish a minimum of 1 metre behind each side of the front facade (not including the entry feature/porch);
- 6.5. At the required point of finish behind the front facade, each side boundary fence must return at 90 degrees to abut the dwelling. Return fences must be constructed to match the boundary fencing or from timber slats and must be setback to allow for access to the meter boxes;
- 6.6. side boundary fencing along the **secondary street frontage** of a corner lot must:
- 6.6.1. be constructed from capped timber palings with exposed timber posts (75mm x 125mm);
- 6.6.2. not exceed 1.95 metres in height;
- finish at least 3 metres behind the front facade of the dwelling and behind the corner treatment, whichever is the greater.
- 6.7. For **rear loaded lots** where the rear boundary abuts a reserve, the fencing on the boundary abutting the reserve must:
- 6.7.1. be constructed from capped timber palings with exposed timber posts (75mm x 125mm);
- 6.7.2. not exceed 1.95 metres in height;
- be approved by the DRC and constructed to the requirements of the Planning Permit and any endorsed plan forming part of that Planning Permit.

Memorandum of common provisions

Section 91A Transfer of Land Act 1958

7. Dwelling Design Approval

7.1. The design of any building or structure to be constructed on a lot within 8 years of the registration of the plan of subdivision creating the lot must:

7.1.1. comply with the Riverfield Design Guidelines; and

7.1.2. receive approval of all plans and specifications by Riverfield Estate Design Assessment Panel c/-Brown Property Group, Level 5, 523 Burwood Road, Hawthorn, Victoria, 3122 prior to a building permit being procured for any such building or structure.

7.2. Orientation of Dwelling on rear loaded lots

The dwelling constructed on a **rear loaded lot** must be designed to address the boundary of the lot opposite that which is marked for vehicular access to the garage, with pedestrian access (the entry) facing this boundary (i.e. to address the boundary abutting the reserve or primary road frontage, as the case may be).

8. Driveways

8.1. A driveway must be fully constructed prior to occupancy of any dwelling constructed on the Lot.

8.2. The driveway must be constructed of exposed aggregate, pavers, stamped or stencilled surfacing or coloured concrete as approved by the DRC.

8.3. The driveway must be setback at least 500 millimetres from the nearest side boundary to allow for the establishment of landscaped garden along that side boundary.

8.4. Relocation of a driveway crossover or, addition of a driveway crossover to a corner lot, is permitted with the written approval of DRC and Casey City Council. Relocated crossovers must be constructed at the lot owners expense to the specification of Casey City Council and be of the same finish as that originally provided by Riverfield.

9. Permission to construct contrary to these MCPs and any Building Envelope

The requirements of these MCPs may be varied with the consent of the Responsible Authority.

10. Notes on this MCP

10.1. In the case of conflict between the building envelope plans and these written notations, the specifications in the written notations prevail.

10.2. Ground level after engineering works associated with subdivision is to be regarded as natural ground level.

10.3. Buildings must not cover registered easements unless approved by the relevant authority.

10.4. The construction of a building which is contrary to the requirements of this MCP may occur with the written consent of Riverfield and the Responsible Authority, where consent of the Responsible Authority is required by the Scheme, any planning permit affecting the lot or by operation of the law.

Memorandum of common provisions

Section 91A Transfer of Land Act 1958

11. General Definitions

- 11.1. **approved building envelope** means the building envelope shown for a particular lot in the building envelope plans and has the same meaning as in regulation 71 of the Regulations;
- 11.2. **building** has the same meaning as in the Building Act;
- 11.3. **Building Act** means the act of the Victorian Parliament known as the Building Act 1993 and any re-enactment or replacement of that act;
- 11.4. **building envelope** means an area within each lot (defined by the particular lot setbacks) where development of a dwelling, shed, garage is allowed subject to the particular provisions of this MCP and the Scheme;
- 11.5. **building envelope plans** means the plans which are attached to this MCP which show the approved building envelopes, setback requirements and other related matters for individual lots within the plan of subdivision;
- 11.6. **building permit** means a building permit in terms of the Building Act;
- 11.7. **Code** means the Small Lot Housing Code incorporated as a document in the Scheme;
- 11.8. **control** includes a restriction in terms of the Subdivision Act 1988, an agreement under section 173 of the Planning and Environment Act 1987 (PE Act), a provision of an Act (other than the Building Act), a regulation (other than the Building Regulations), a requirement of a referral authority (in terms of section 55 of the PE Act) or an order of a Court or tribunal, which relates to the siting of a Building;
- 11.9. **DRC** means the Riverfield Design Review Committee appointed by Riverfield and comprising representative of developer and a qualified architect for the purposes of assessing compliance by Lot owners with the Riverfield Design Guidelines;
- 11.10. **dwelling** has the same meaning as in the Scheme;
- 11.11. **Edge lots** are those lots that are part of the same certified plan of subdivision but share one or more common boundaries with or otherwise adjoin a lot that is not part of the same certified plan of subdivision.
- 11.12. **frontage** has the same meaning as in the Scheme;
- 11.13. **height** has the same meaning as in the Regulations,
- 11.14. **lot** has the same meaning as in the Subdivision Act 1988 and any re-enactment or replacement of that act;
- 11.15. **MCP** means this memorandum of common provisions;
- 11.16. **Riverfield Design Guidelines** means the design guidelines prepared by Riverfield and Brown Property Group, as amended from time to time
- 11.17. **on the boundary** means a setback of up to 200 millimetres from the lot/property title boundary is deemed to be on the boundary;
- 11.18. **plan of subdivision** means the plan of subdivision to which this MCP is incorporated by way of a restrictions on that plan of subdivision;

Memorandum of common provisions

Section 91A Transfer of Land Act 1958

- 11.19. **Primary frontage** is the boundary with the greater setback on the Building Envelope Plan
- 11.20. **rear loaded lot** means a lot on the building envelope plan bearing the identifier code “RL” on the building envelope plans;
- 11.21. **Regulations** means the Building Regulations 2018 or any subsequent regulations made pursuant to the Building Act which relate to the siting of a Building;
- 11.22. **reserve** has the meaning given to it in the Subdivision Act 1988 (Vic);
- 11.23. **Scheme** means the planning scheme of the local authority responsible for the land contained within the plan of subdivision;
- 11.24. **Secondary Frontage** is any boundary that abuts a road or reserve, other than the primary frontage
- 11.25. **setback** has the same meaning as in the Regulations;
- 11.26. **side boundary** means a boundary of a lot that runs between and connects the street frontage of the lot to the rear boundary of the lot;
- 11.27. **Side Loaded lot** means a lot whereby the garage opening addresses the secondary frontage. This is usually a corner lot.
- 11.28. **Small Lot Housing Code** refers to the Small Lot Housing Code incorporated in the Scheme pursuant to Clause 81 of the Scheme;
- 11.29. **storey** has the same meaning as in the Scheme;
- 11.30. **street**, for the purposes of determining street setbacks, means any road other than a footway or carriageway easement;
- 11.31. **Type A** on a building envelope plan denotes that the lot is one to which the provisions of the Small Lot Housing Code relating to Type A allotments applies; and
- 11.32. **Type B** on a building envelope plan denotes that the lot is one to which the provisions of the Small Lot Housing Code relating to Type B allotments applies.

Expiry:

As set out in the Plan of Subdivision (if applicable); and

A building envelope will cease to apply to any building on the lot affected by the building envelope after the issue of a certificate of occupancy for the whole of a dwelling on the land.

Memorandum of common provisions

Section 91A Transfer of Land Act 1958

12. Diagrams and Plans

12.1 Diagram illustrating the interpretation of the building envelope and the annotation with respect to all edge lots in this stage development

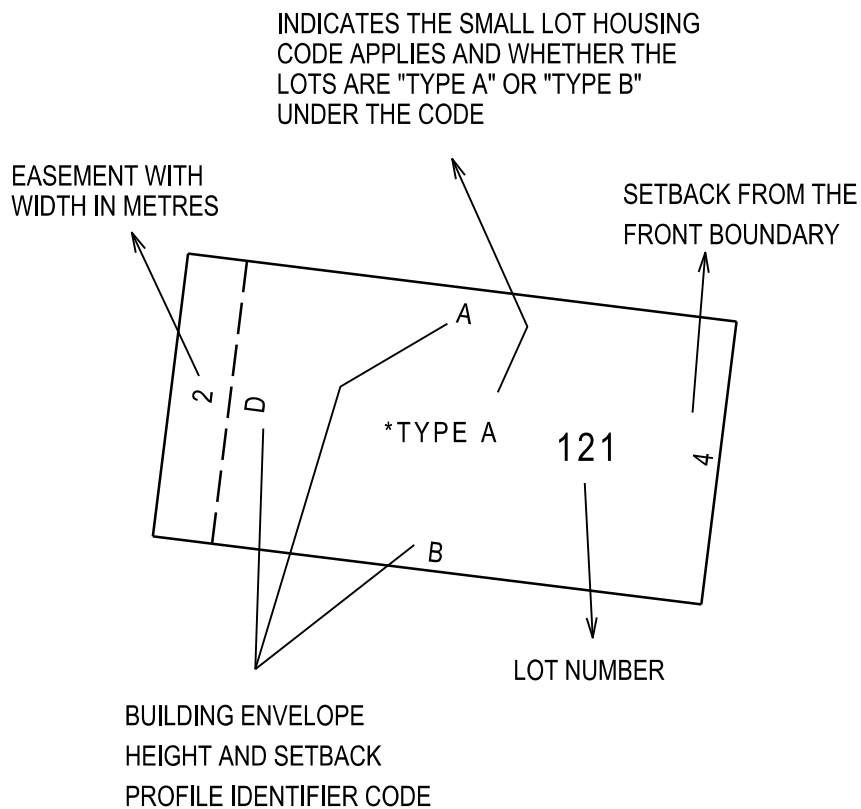

Memorandum of common provisions

Section 91A Transfer of Land Act 1958

12.2 Building height & setback profiles referenced in the building envelope plan

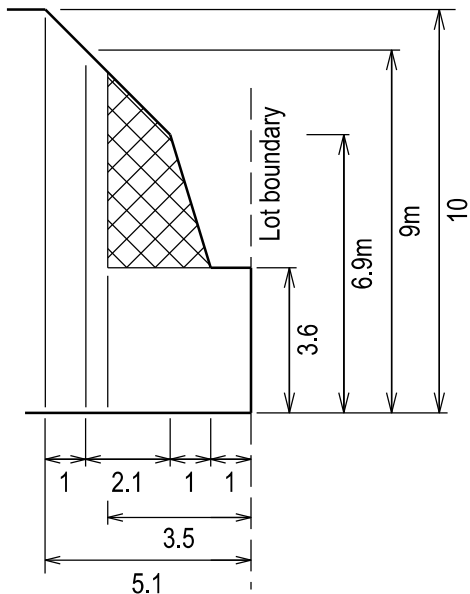

Side boundary shared with the side or rear boundary of a residential lot in the same development stage

PROFILE (A)

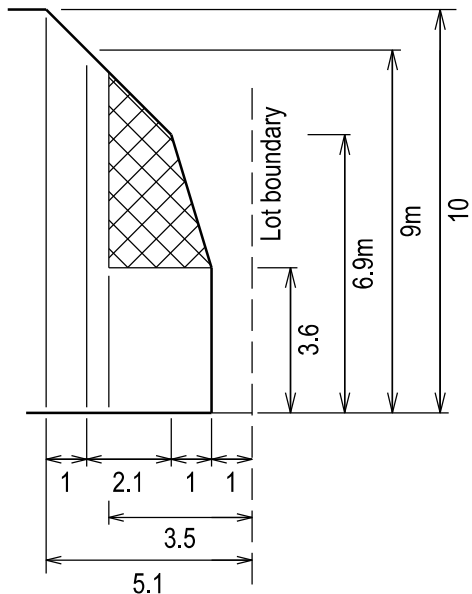

Side boundary shared with the side or rear boundary of a residential lot in the same development stage

PROFILE (B)

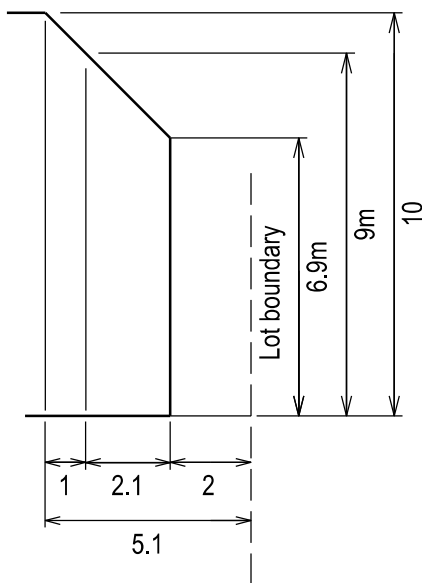

Side boundary abutting a street or public open space

PROFILE (C)

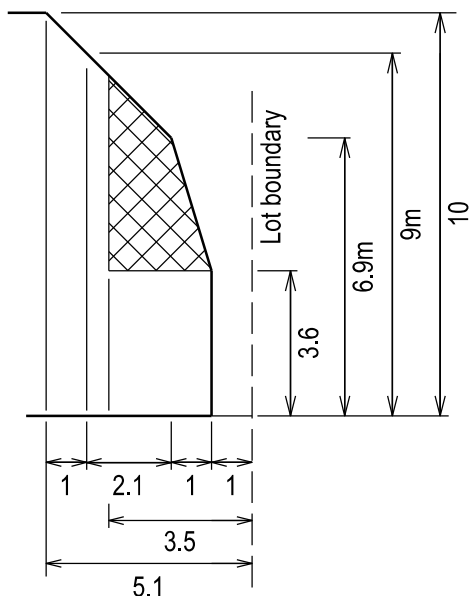

Rear boundary adjoining the rear or side boundary of a residential lot

PROFILE (D)

EASEMENT REQUIREMENT

WHERE A PROFILE WHEN APPLIED COVERS AN EASEMENT, THE PORTION OF THE PROFILE ABOVE THE EASEMENT CANNOT BE CONSIDERED FOR APPROVAL/BUILT UPON. THIS MAY VARY ONLY IN THE CIRCUMSTANCES WHERE BUILDING ON THE EASEMENT RECEIVES PRIOR WRITTEN CONSENT OF THE RELEVANT AUTHORITY.



OVERLOOKING CONTROL AREA (refer 'overlooking' in MCP)

ALL DIMENSIONS ARE IN METRES UNLESS NOTED OTHERWISE

Memorandum of common provisions
Section 91A Transfer of Land Act 1958

12.3 Diagram illustrating the interpretation of the building envelope and the annotation with respect to all edge lots in this stage development

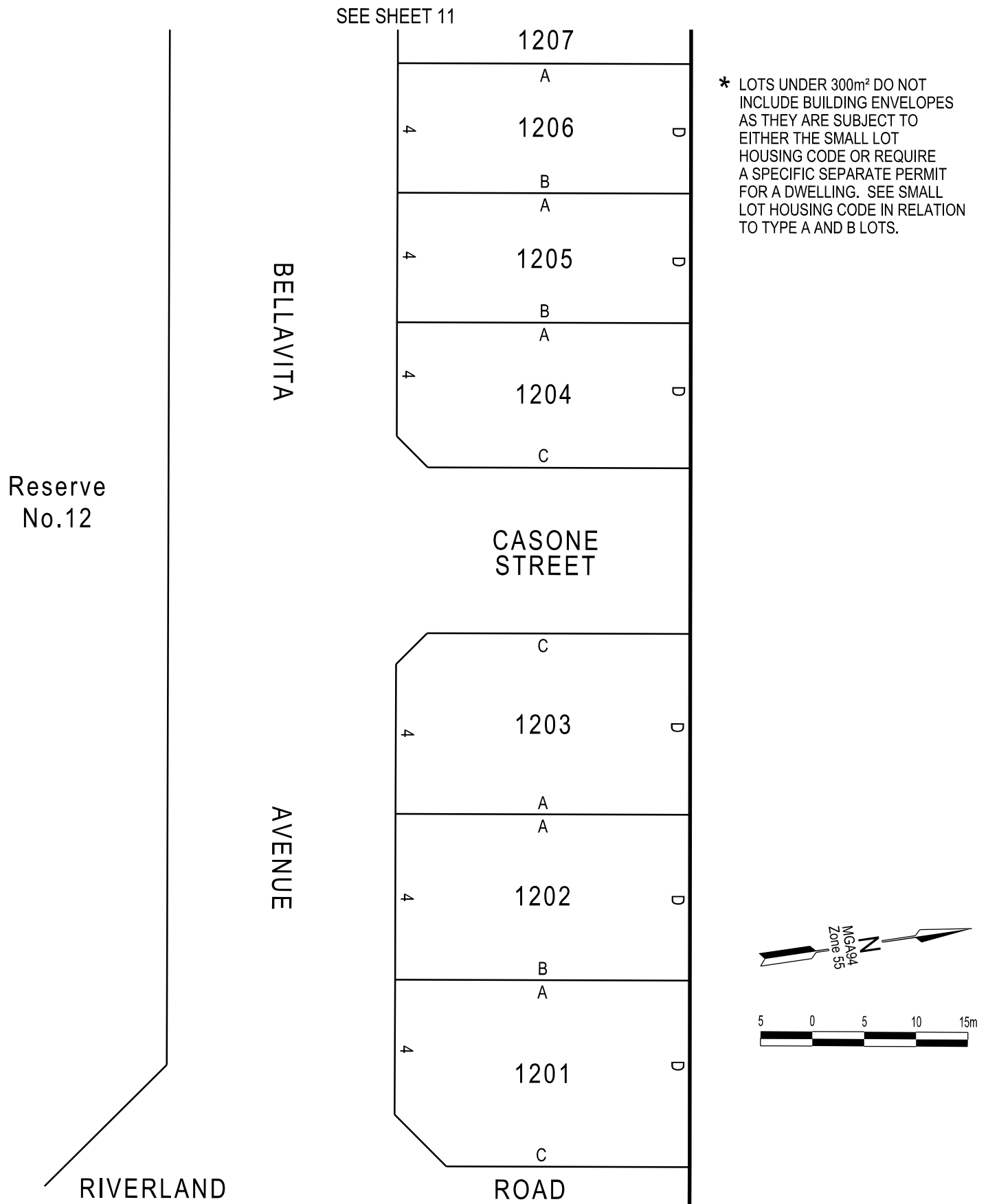

Memorandum of common provisions
Section 91A Transfer of Land Act 1958

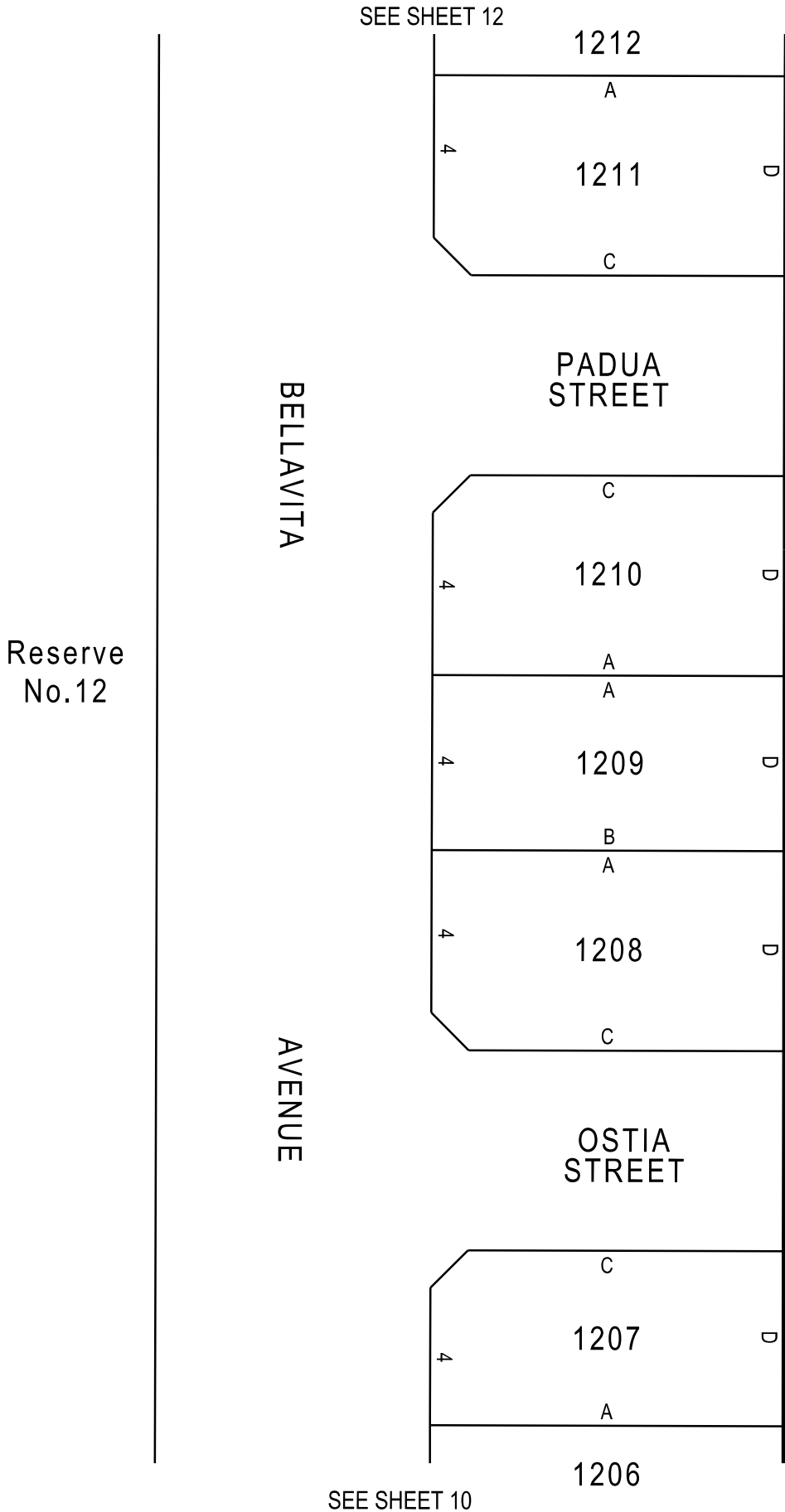

* LOTS UNDER 300m² DO NOT INCLUDE BUILDING ENVELOPES AS THEY ARE SUBJECT TO EITHER THE SMALL LOT HOUSING CODE OR REQUIRE A SPECIFIC SEPARATE PERMIT FOR A DWELLING. SEE SMALL LOT HOUSING CODE IN RELATION TO TYPE A AND B LOTS.

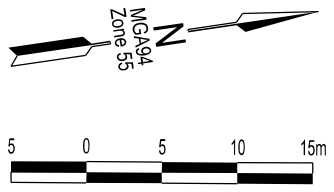

Memorandum of common provisions
Section 91A Transfer of Land Act 1958

SEE SHEET 13

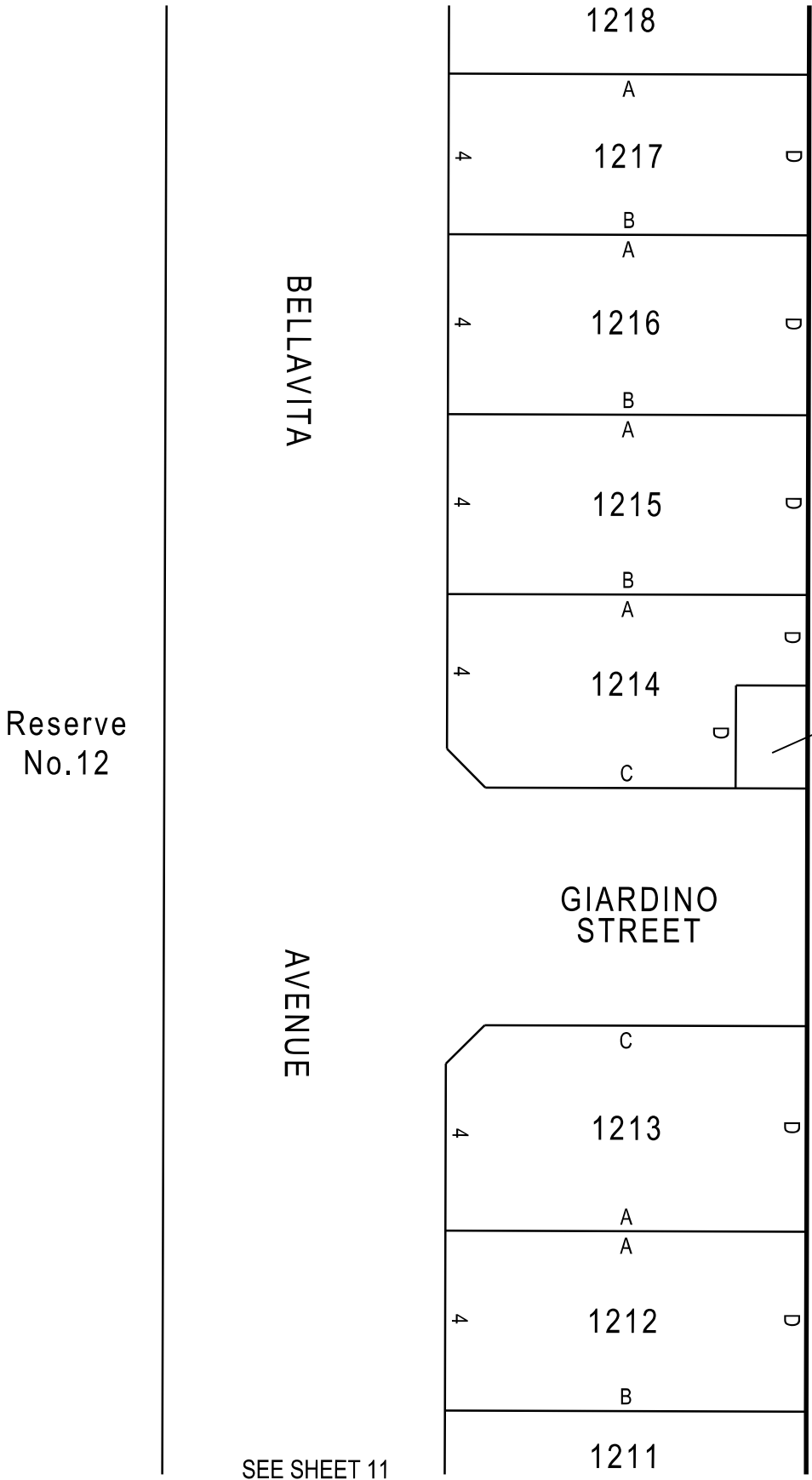

* LOTS UNDER 300m² DO NOT INCLUDE BUILDING ENVELOPES AS THEY ARE SUBJECT TO EITHER THE SMALL LOT HOUSING CODE OR REQUIRE A SPECIFIC SEPARATE PERMIT FOR A DWELLING. SEE SMALL LOT HOUSING CODE IN RELATION TO TYPE A AND B LOTS.

Reserve No.13

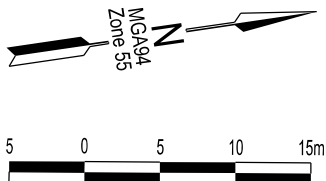

Reserve No.12

SEE SHEET 11

Memorandum of common provisions
Section 91A Transfer of Land Act 1958

SEE SHEET 14

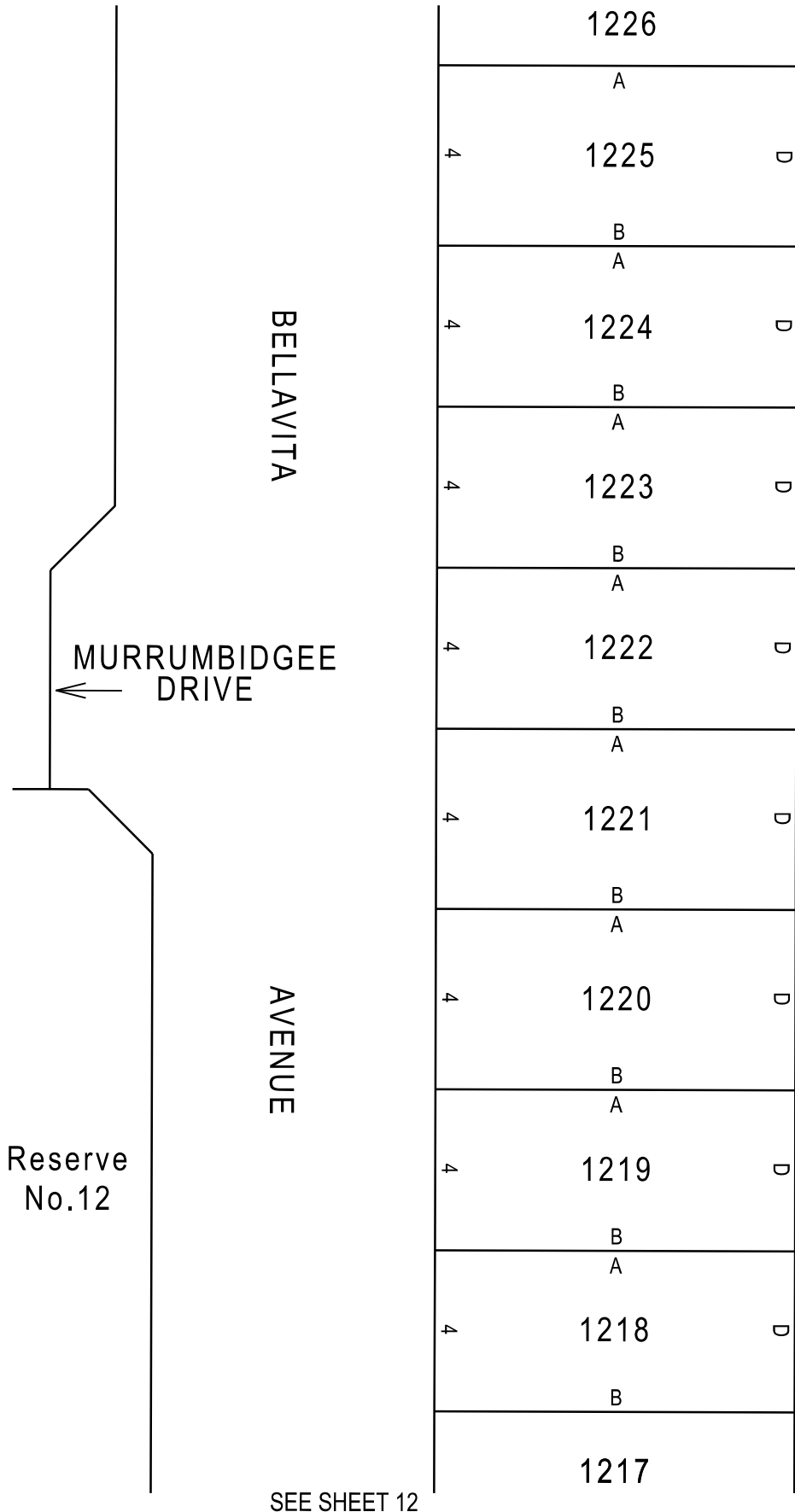

* LOTS UNDER 300m² DO NOT INCLUDE BUILDING ENVELOPES AS THEY ARE SUBJECT TO EITHER THE SMALL LOT HOUSING CODE OR REQUIRE A SPECIFIC SEPARATE PERMIT FOR A DWELLING. SEE SMALL LOT HOUSING CODE IN RELATION TO TYPE A AND B LOTS.

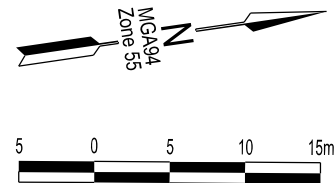

SEE SHEET 12

91ATLA

Page 13 of 17

V3

THE BACK OF THIS FORM MUST NOT BE USED

Land Use Victoria contact details: see www.delwp.vic.gov.au/property > Contact us

Memorandum of common provisions
Section 91A Transfer of Land Act 1958

SEE SHEET 15

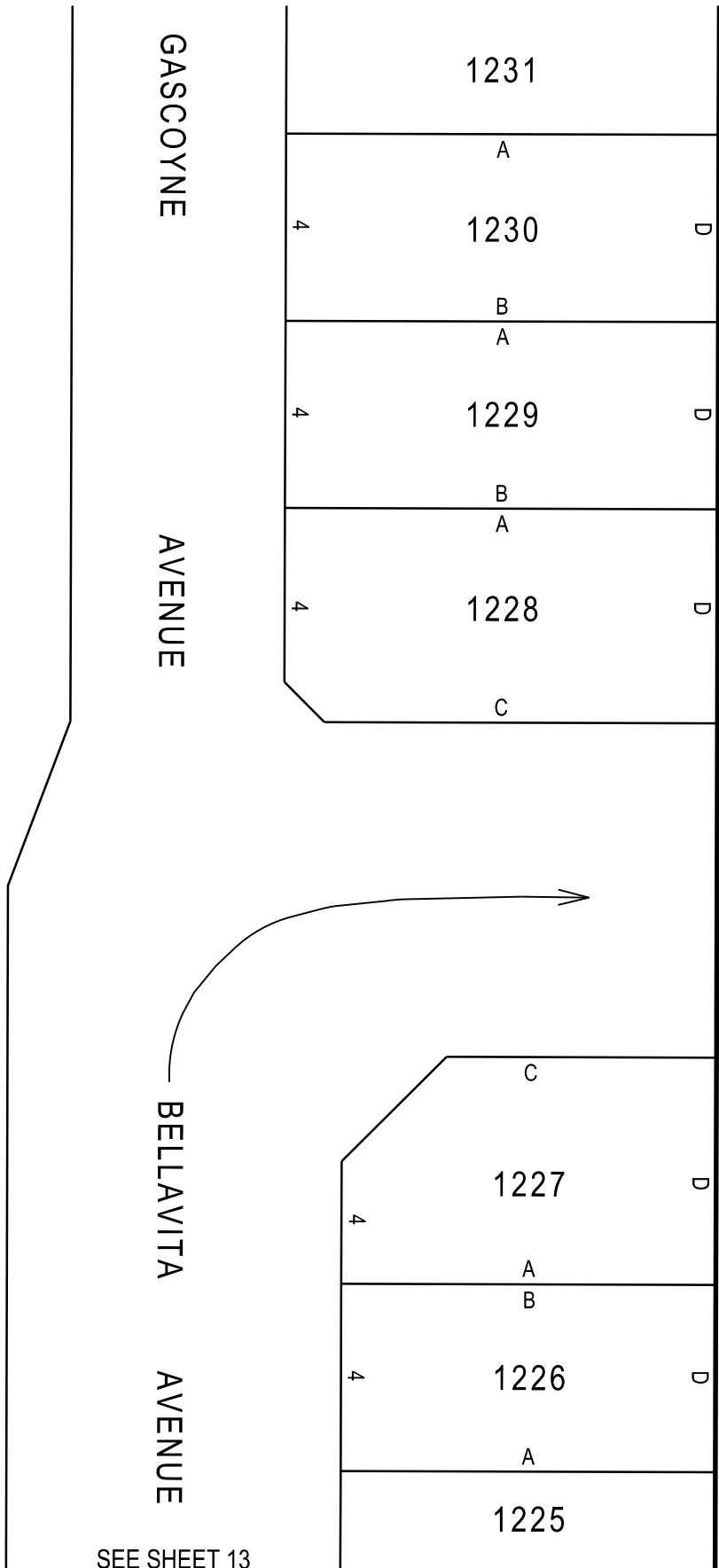

* LOTS UNDER 300m² DO NOT INCLUDE BUILDING ENVELOPES AS THEY ARE SUBJECT TO EITHER THE SMALL LOT HOUSING CODE OR REQUIRE A SPECIFIC SEPARATE PERMIT FOR A DWELLING. SEE SMALL LOT HOUSING CODE IN RELATION TO TYPE A AND B LOTS.

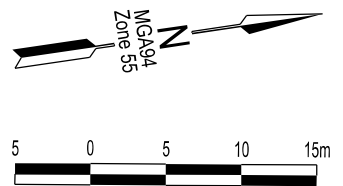

SEE SHEET 13

Memorandum of common provisions
Section 91A Transfer of Land Act 1958

SEE SHEET 16

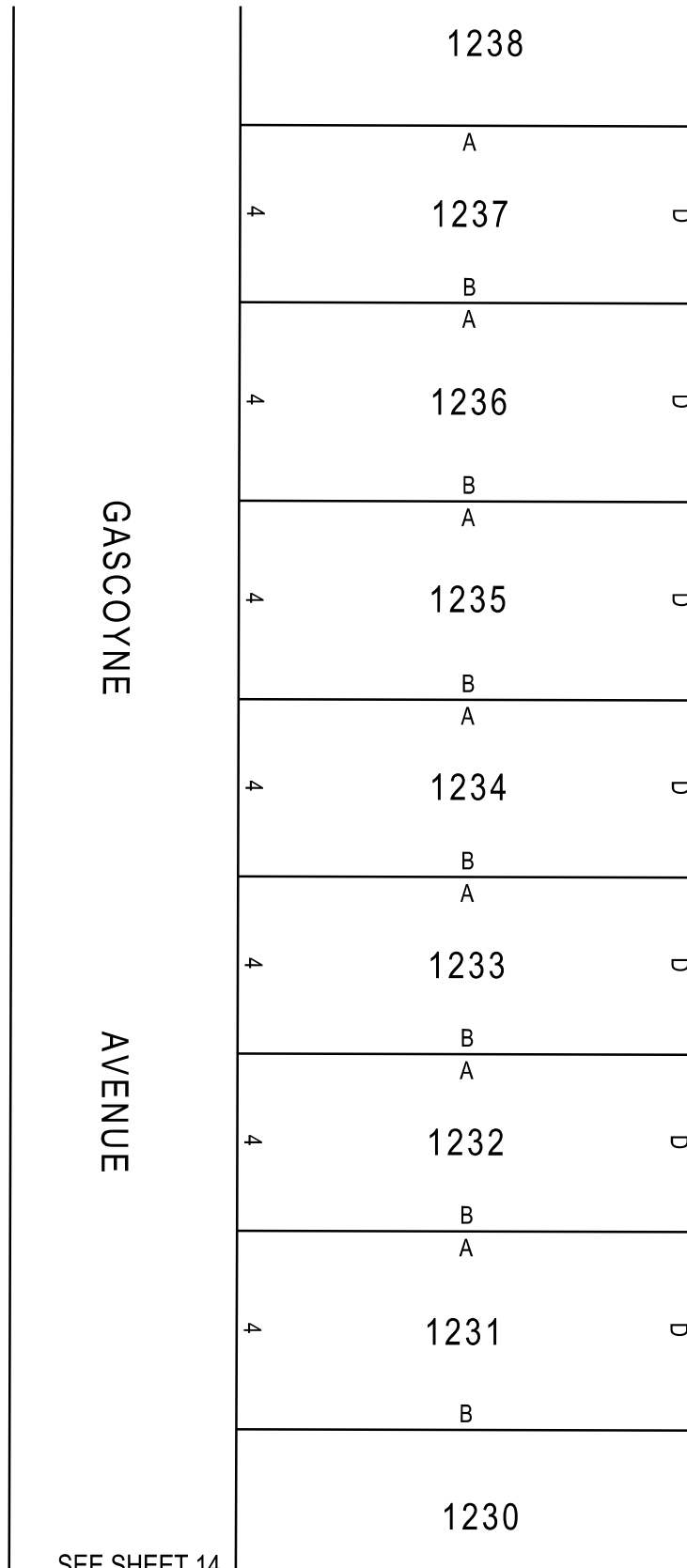

SEE SHEET 14

* LOTS UNDER 300m² DO NOT INCLUDE BUILDING ENVELOPES AS THEY ARE SUBJECT TO EITHER THE SMALL LOT HOUSING CODE OR REQUIRE A SPECIFIC SEPARATE PERMIT FOR A DWELLING. SEE SMALL LOT HOUSING CODE IN RELATION TO TYPE A AND B LOTS.

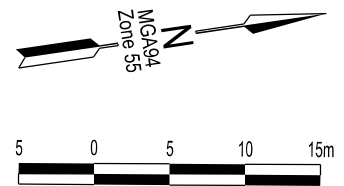

Memorandum of common provisions
Section 91A Transfer of Land Act 1958

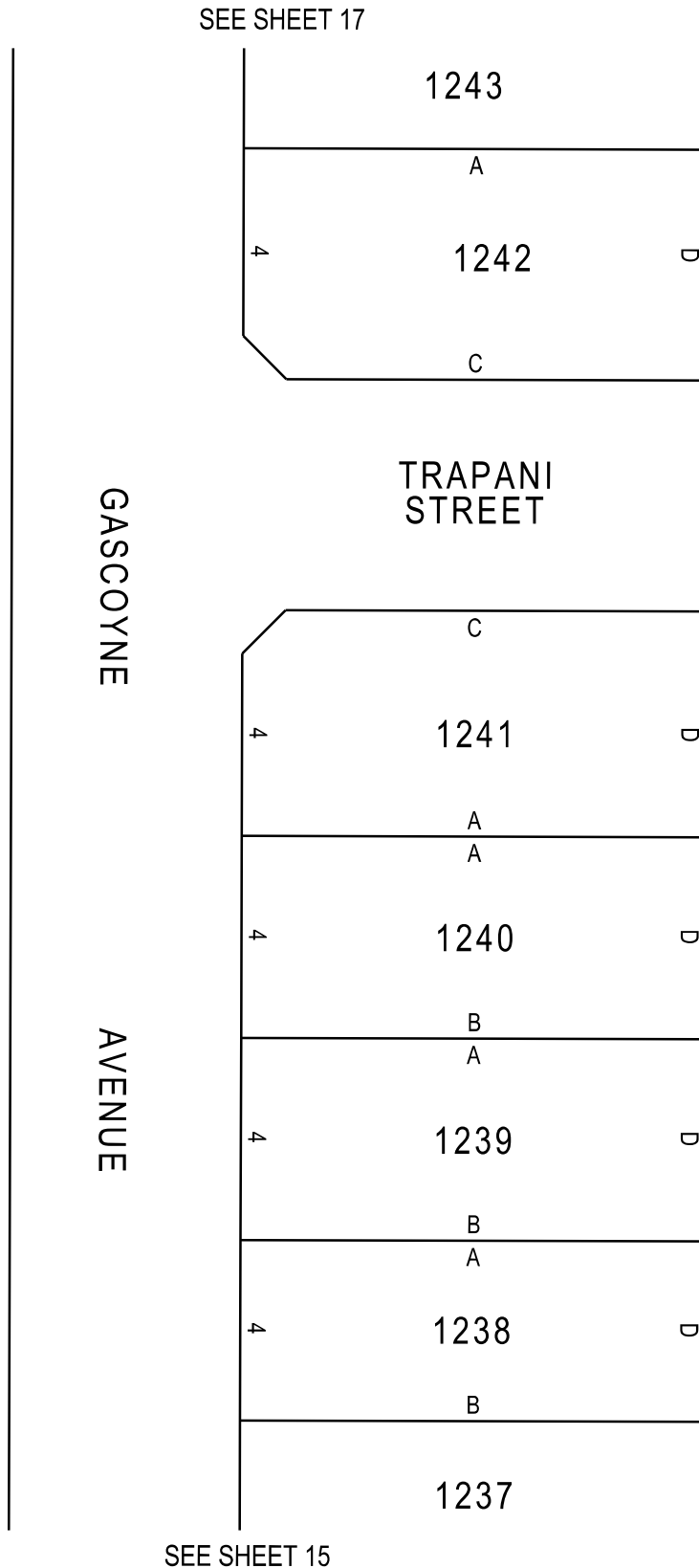

* LOTS UNDER 300m² DO NOT INCLUDE BUILDING ENVELOPES AS THEY ARE SUBJECT TO EITHER THE SMALL LOT HOUSING CODE OR REQUIRE A SPECIFIC SEPARATE PERMIT FOR A DWELLING. SEE SMALL LOT HOUSING CODE IN RELATION TO TYPE A AND B LOTS.

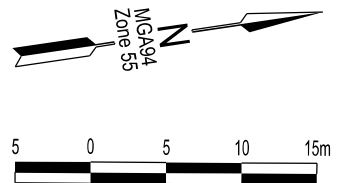

Memorandum of common provisions
Section 91A Transfer of Land Act 1958

* LOTS UNDER 300m² DO NOT INCLUDE BUILDING ENVELOPES AS THEY ARE SUBJECT TO EITHER THE SMALL LOT HOUSING CODE OR REQUIRE A SPECIFIC SEPARATE PERMIT FOR A DWELLING. SEE SMALL LOT HOUSING CODE IN RELATION TO TYPE A AND B LOTS.

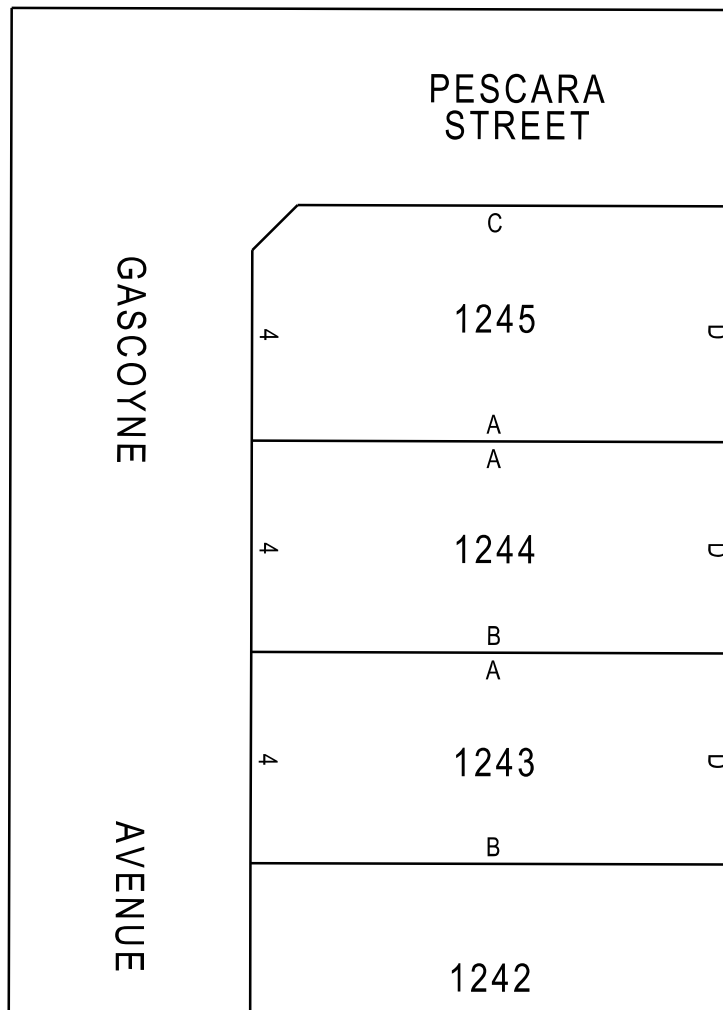

SEE SHEET 16

